

# PLUS

Automatic horizontal sliding landing door



# Door configuration



## LIFT APPLICATION

Door cycles per year:	Up to 800.000.
Traffic peak of the door:	Up to 240 cycles per hour.
Traffic lift speed:	Up to 3 m/s.

## APPLICATION RANGE

Opening	Clear opening - PL (mm)	Clear height - HL (mm)
T2	700 - 900	2.000 - 2.100

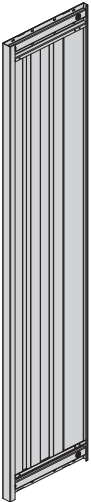
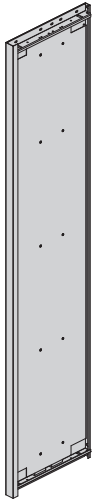
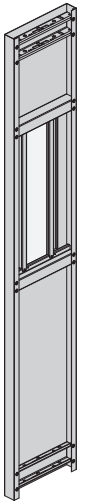
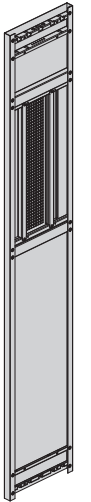
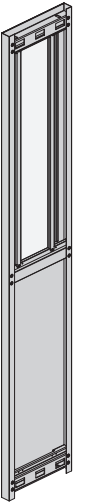
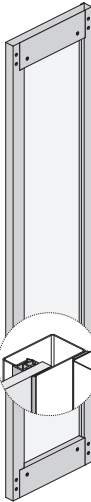
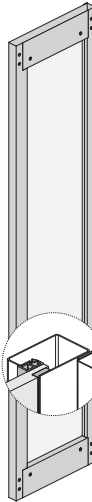
## PANELS

Opening	Steel panels					Glass panels			
	Sheet metal	Double skin	Vision	Fritted vision	Wien type vision	Bevel big vision	Flush big vision	Full glass in skirting	Full glass in moorings
T2									
	F.R. E120	x	x	x	x	x	x	x	x

F.R.: Fire Rated according to EN 81-58.

## FRAMES DEFINITION

Frame depth (mm)	Jamb J1 (mm)	Header (mm)	Jamb J2 (mm)	Remarks	Frame type				Options			
					STD	MSS MV	MSS MH	Concealed	Lateral covers	Without extra-stroke	MRL	Without lateral punching
60	120	160	120	-	✓	x	x	x	x	x	x	✓

MSS MV: Frame without sill supplement with visible sill support.  
MSS MH: Frame without sill supplement with concealed sill support.  
Without extra-stroke: Closing jamb without labyrinth.  
MRL: Jamb ready for lift control cabinet in machine roomless installations.

Available<sup>(1)</sup>  Not available.  Ask the commercial department.

<sup>1</sup> Some option combinations may not be possible.



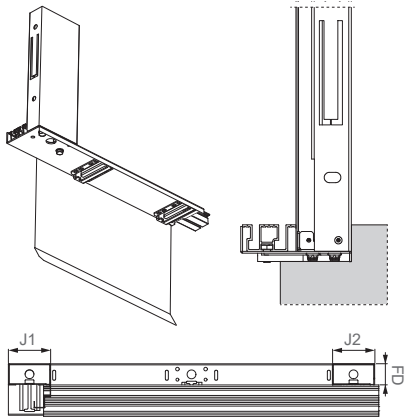

# Door configuration

## FRAMES DETAIL



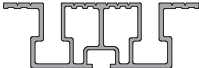

Frame detail	Frame type	
	STD	Concealed
		-
	MSS MV	MSS MH
	-	-

MSS MV: Frame without sill supplement with visible sill support.  
MSS MH: Frame without sill supplement with concealed sill support.

## SILLS

Type of sill	Aluminium	Reinforced aluminium	Steel	Steel concealed	Massive
Profile detail					
Availability	✓	✗	✗	✗	✗
Heated sill option	✗	✗	✗	✗	✗
Dust holes	✓	✗	✗	✗	✗

## SILL SUPPLEMENTS

Type of supplement	Aluminium	Reinforced aluminium	Steel	Massive
Profile detail				
Availability	✓	✗	✗	✗

Available<sup>(1)</sup>  Not available.  Ask the commercial department.

<sup>1</sup> Some option combinations may not be possible.

# Door configuration

## STANDARDS

Opening	EN 81-20/50 Safety rules	EN 81-1/2 Safety rules	EN 81-21 Existing buildings	EN 81-41 Impaired mobility	EN 81-71 Vandal resistance lifts		EN 81-72 Firefighters lifts
					Cat. I	Cat. II	
T2	✓	✓	✗	✗	✗	✗	✗

## PROTECTION

Opening	IP20 Protection against a solid foreign body of 12,5 mm or more in diameter.	IPX3 Protected against sprays of water up to 60 degrees from the vertical.	IP54 Protection against dust and protected against water splashed from all directions.		IP65 Sealed against dust and protected against jets of water from all directions.	EEEx Explosion proof, Group II (surface industries) and Category 2 (explosive atmosphere between 10 and 1.000 hrs/yr).
			Magnetic contact	Mechanical contact		
T2	✓	✗	✗	✗	✗	✗

## PANEL REGULATION SUPPORT AND PANEL GUIDE

Type of panel regulation support	Direct fastening	
Type of panel guide	Advanced	Sill track 8 mm 

## COMPATIBILITY

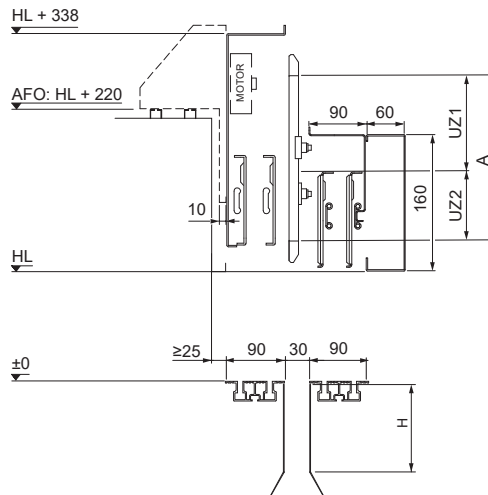

Case	40/10 PM car door					
Coupling	Symmetrical clutch					
Unlocking zone	CDL Standard		CDL extended		CDL pre-opening	
A	250		340		500	
UZ	UZ1	UZ2	UZ1	UZ2	UZ1	UZ2
	193	57	193	147	309	191
Toe guard type	Standard					
H	265			395		
Thickness	1					
Range	All					
T2 opening shown. If not otherwise indicated all dimensions in mm.						

Available<sup>(1)</sup>    Not available.    Ask the commercial department.

<sup>1</sup> Some option combinations may not be possible.

# Door configuration

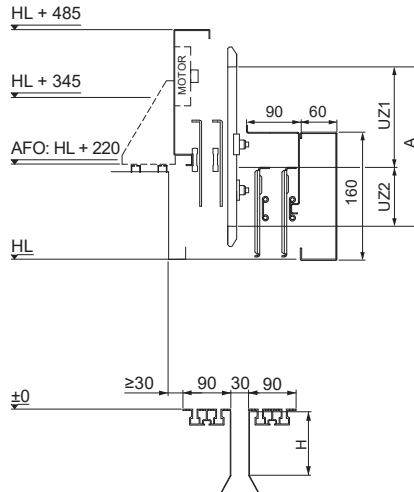

Case	50/11 PM MEGA car door		
Coupling	Symmetrical clutch		
Unlocking zone	CDL Standard		
A	393		
UZ	UZ1		UZ2
	310		83
Toe guard type	Standard		
H	395		
Thickness	1		
Range	All		
T2 opening shown. If not otherwise indicated all dimensions in mm.			

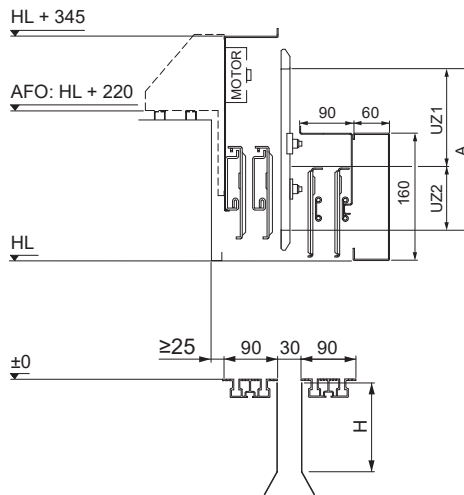

Case	Premium PM car door					
Coupling	Symmetrical clutch					
Unlocking zone	CDL Standard		CDL extended		CDL pre-opening	
	250		340		500	
UZ	UZ1	UZ2	UZ1	UZ2	UZ1	UZ2
	206	44	206	134	317	183
Toe guard type	Standard					
H	265				395	
Thickness	1					
Range	All					
T2 opening shown. If not otherwise indicated all dimensions in mm.						

Available<sup>(1)</sup>.  Not available.  Ask the commercial department.

<sup>1</sup> Some option combinations may not be possible.

# Technical features

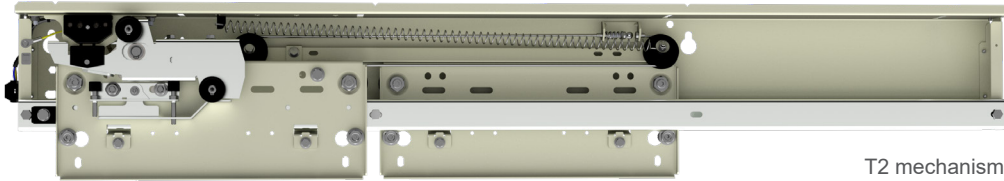

T2 mechanism

## GENERAL FEATURES

Noise level	< 50 dB.
Total weight	Reference: T2 PL 700 mm HL 2.000 mm 120 x 60 mm frame, with sheet metal panels - 68 kg.
Safety closing system	With spring.

## INSTALLATION

Pre-adjusted and tested to simplify the installation.

## DOOR HOISTWAY PROJECTION (DHP) - FIXING BRACKETS

DHP type	T2	
	DHP <sup>(2)</sup> (mm)	Bracket
		Ⓚ
1	0-38	X A
2a	38-89	W
2b	90-140	D
3a	141-150	V2

Bracket type	X	W	D	A	V2
	Thickness (mm)	5	5	4	5

<sup>(2)</sup> See DHP dimension in sill detail (technical drawings pages).

UPPER FASTENING BRACKET QUANTITY	
Opening	PL
	700 - 900
T2	2

LOWER FASTENING BRACKET QUANTITY	
Opening	PL
	700 - 900
T2	3

# Technical drawing 2 panel side opening door

90 mm sill

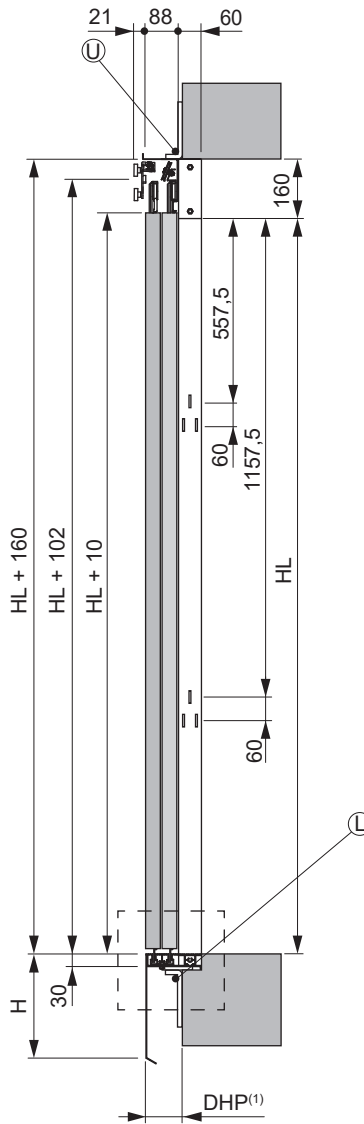
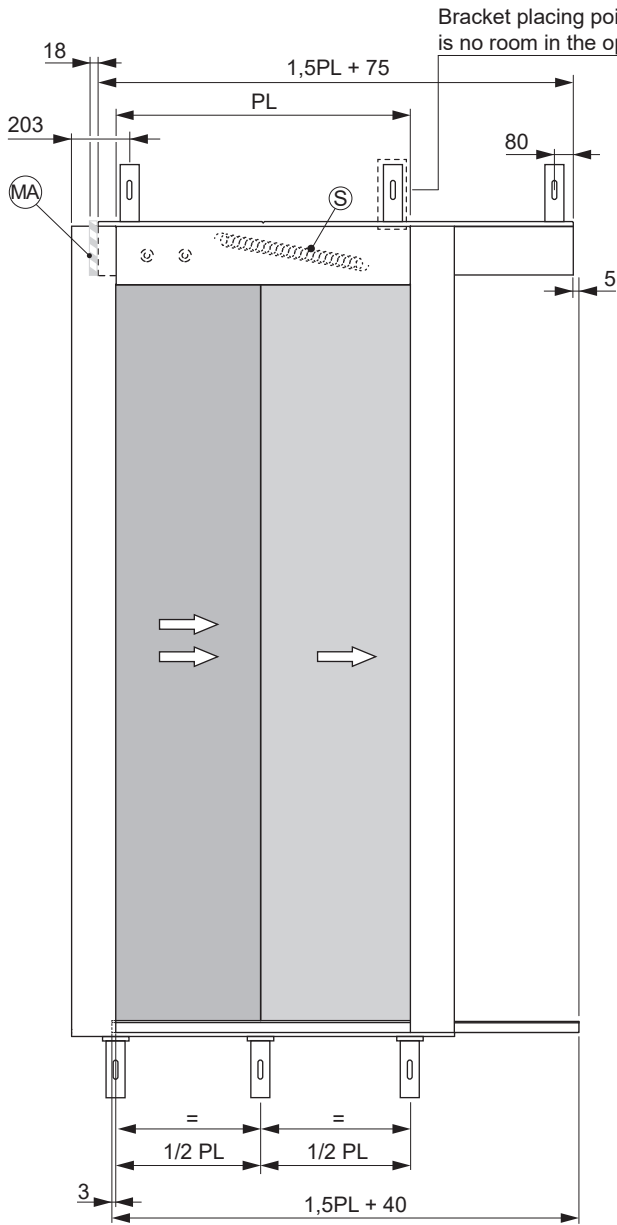

## MECHANICAL DETAILS

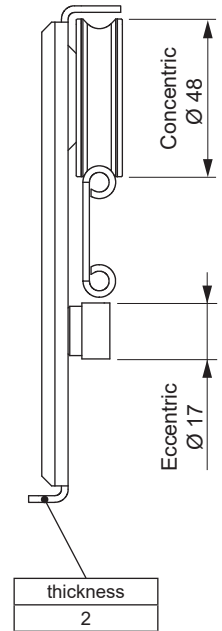

## SILL DETAIL

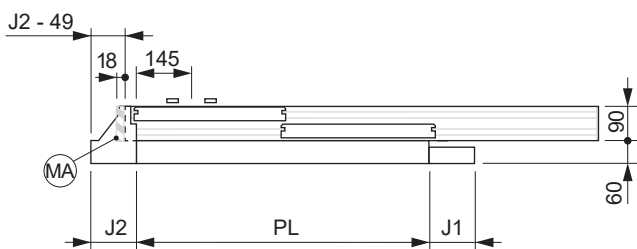
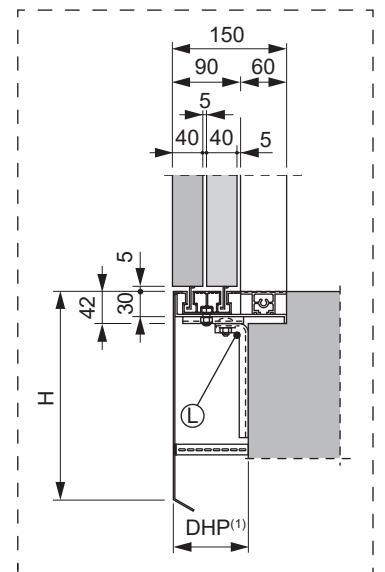

DHP	
U	Upper bracket
L	Lower bracket
Safety closing system	
S	Spring

### Notes:

(1) See DHP details in technical features page.  
MA Mechanism hardware area.

- If not otherwise indicated all dimensions in mm.



## Sales contacts

### General

[info@fermator.com](mailto:info@fermator.com)

### Manufacturing companies

Brazil: [info.br@fermator.com](mailto:info.br@fermator.com) • China: [info.cn@fermator.com](mailto:info.cn@fermator.com) • France: [info.hp@fermator.com](mailto:info.hp@fermator.com) • India: [info.in@fermator.com](mailto:info.in@fermator.com)  
Italy: [info.it@fermator.com](mailto:info.it@fermator.com) • Poland: [info.pl@fermator.com](mailto:info.pl@fermator.com) • Spain: [info.es@fermator.com](mailto:info.es@fermator.com)

### Trading companies

France: [info.ff@fermator.com](mailto:info.ff@fermator.com) • Germany: [info.de@fermator.com](mailto:info.de@fermator.com) • Middle East: [info.tr@fermator.com](mailto:info.tr@fermator.com)  
Nordic countries: [info.se@fermator.com](mailto:info.se@fermator.com) • United Kingdom: [info.uk@fermator.com](mailto:info.uk@fermator.com)

[www.fermator.com](http://www.fermator.com)